

DOPAK® Process Sampler Type DPM system purge configuration (A3)

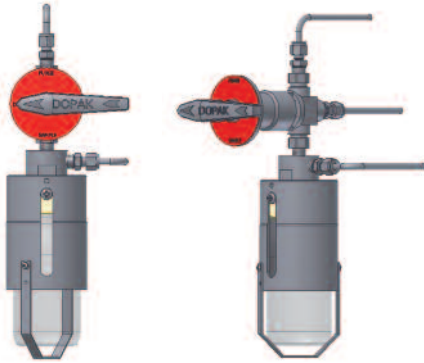

The ability to purge the sample point ensures optimal retrieval of a representative and contamination free sample. The DPM type sampler in system purge configuration allows product to flow continuously through the sampler ensuring a fresh sample.

1 OPERATION/FUNCTION

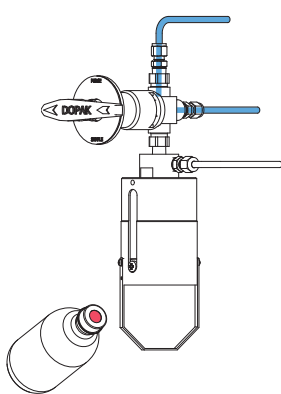

0 - off
Provide a new septum on your sample bottle. Insert the bottle, with cap and septum into the sleeve until the septum is pierced by the needles. Put the bottle retaining clip in place.

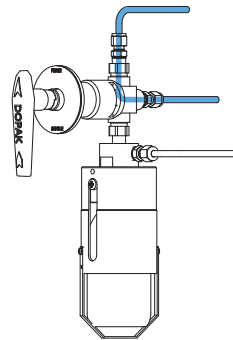

1 - system purge
Turn the handle to the "bypass" position, allowing a continuous flow of liquid through the sampler to ensure representative sampling. This position can be held for any required time.

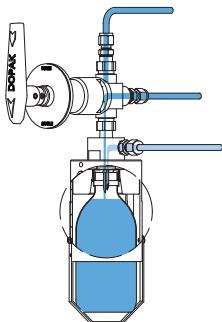

2 - sample
Turn the handle to the "sample" position, allowing the product to flow into the sample bottle. When the required amount has been taken, turn the handle to the "off" position.

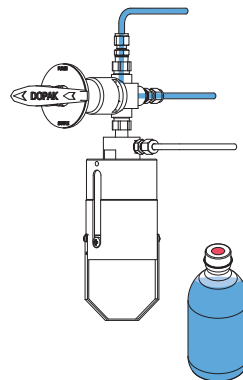

3 - off
Remove the bottle retaining clip and pull the bottle out from the sleeve. The septum reseals automatically.

2 TYPICAL P & ID

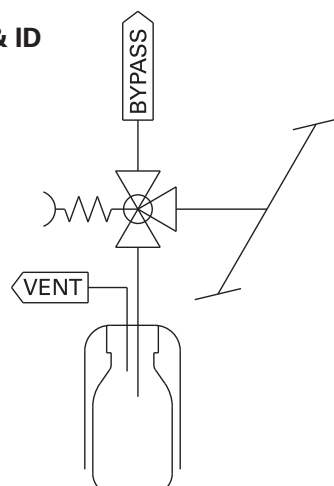

System purge (A3)



3 FEATURES/ADVANTAGES/PROPERTIES

- Sampling directly under process conditions
- Low pressure application
- Representative sampling
- Zero dead volume
- Closed sampling

4 BASIC SPECIFICATIONS

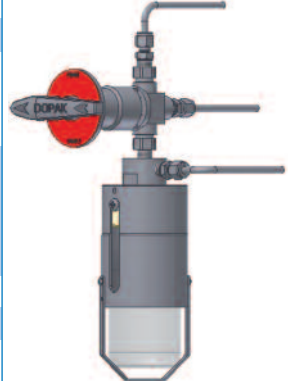
Material	SS316, SS316L.	
Sleeve type	60cc sleeve with bottle retaining clip.	
Needle assembly	Single piece VTO needle assembly with vent to outlet connection 1/4" FNPT. Process/vent needle ID: 1.35 mm.	
Valve	Three-way ball valve type W83. PTFE seats, Viton A O-rings. Pressure range 103 bar @ 20°C (1500 psig @ 70°F). Temperature range -17/+232°C (0/+450°F).	
Operation	Manual.	
Connections	1/4" FNPT.	
Please note:	the above is a basic specification only. DOPAK® Samplers can be offered with a wide variety of options as mentioned below.	

5 OPTIONS

- | | |
|---|---|
| <input type="checkbox"/> Spring return handle | <input type="checkbox"/> Sample cooler |
| <input type="checkbox"/> Lockable handle | <input type="checkbox"/> Mounting bracket |
| <input type="checkbox"/> Mounting plate | <input type="checkbox"/> Steam sterilising cap |
| <input type="checkbox"/> Pipe stand | <input type="checkbox"/> Welded connection |
| <input type="checkbox"/> Block valve | <input type="checkbox"/> Continuous needle purge |
| <input type="checkbox"/> Flow meter | <input type="checkbox"/> Exotic materials |
| <input type="checkbox"/> Enclosure | <input type="checkbox"/> Larger/smaller sample size |

For more information please refer to our sheets:

Options for DOPAK® process samplers, sampling into a bottle.

Components for DOPAK® process samplers.

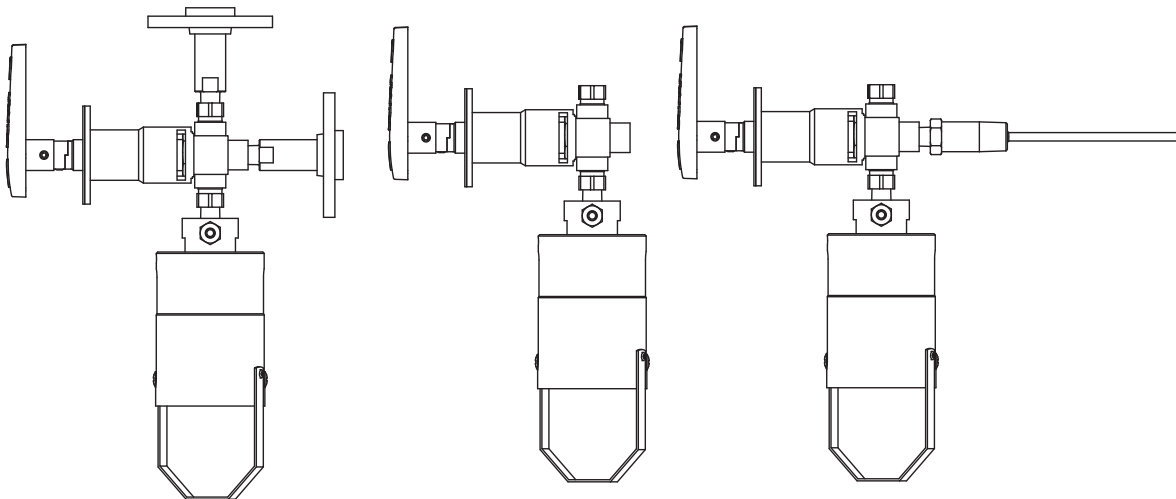

Dopak PFT Corp.

Houston, Texas 77041, USA

Phone 713-460-8311

Fax 713-460-8578

E-mail info-dopak@cranecpe.com

Dovianus BV

Bergschenhoek, The Netherlands

Phone +31 10 524 20 00

Fax +31 10 524 20 29

E-mail info-dovianus@cranecpe.com

Your local distributor